



SYSTEMS

Oscuranti
Shading





Indice

Index

Il nostro ecosistema	<i>Our ecosystem</i>	p. 03
Perchè METRA Building	<i>Why METRA Building</i>	p. 04
Ecosostenibilità	<i>Eco-sustainability</i>	p. 08
Oscuranti	<i>Shading</i>	
• Le nostre linee	• <i>Our product lines</i>	p. 12
• Gli accessori	• <i>The accessories</i>	p. 14
Le linee	<i>The product lines</i>	
• Linea Origini	• <i>Origins line</i>	p. 19
• Linea Scuri	• <i>Blinds Line</i>	p. 25
• Linea Scorrevoli	• <i>Sliding Line</i>	p. 31
• Linea Frangisole	• <i>Sunblades line</i>	p. 37
- Tipologie di frangisole	- <i>Sunblades typologies</i>	p. 42
- Tipologie ovaline	- <i>Oval blades typologies</i>	p. 44
Tecnologia	<i>Technology</i>	p. 46



Il nostro ecosistema

Our ecosystem

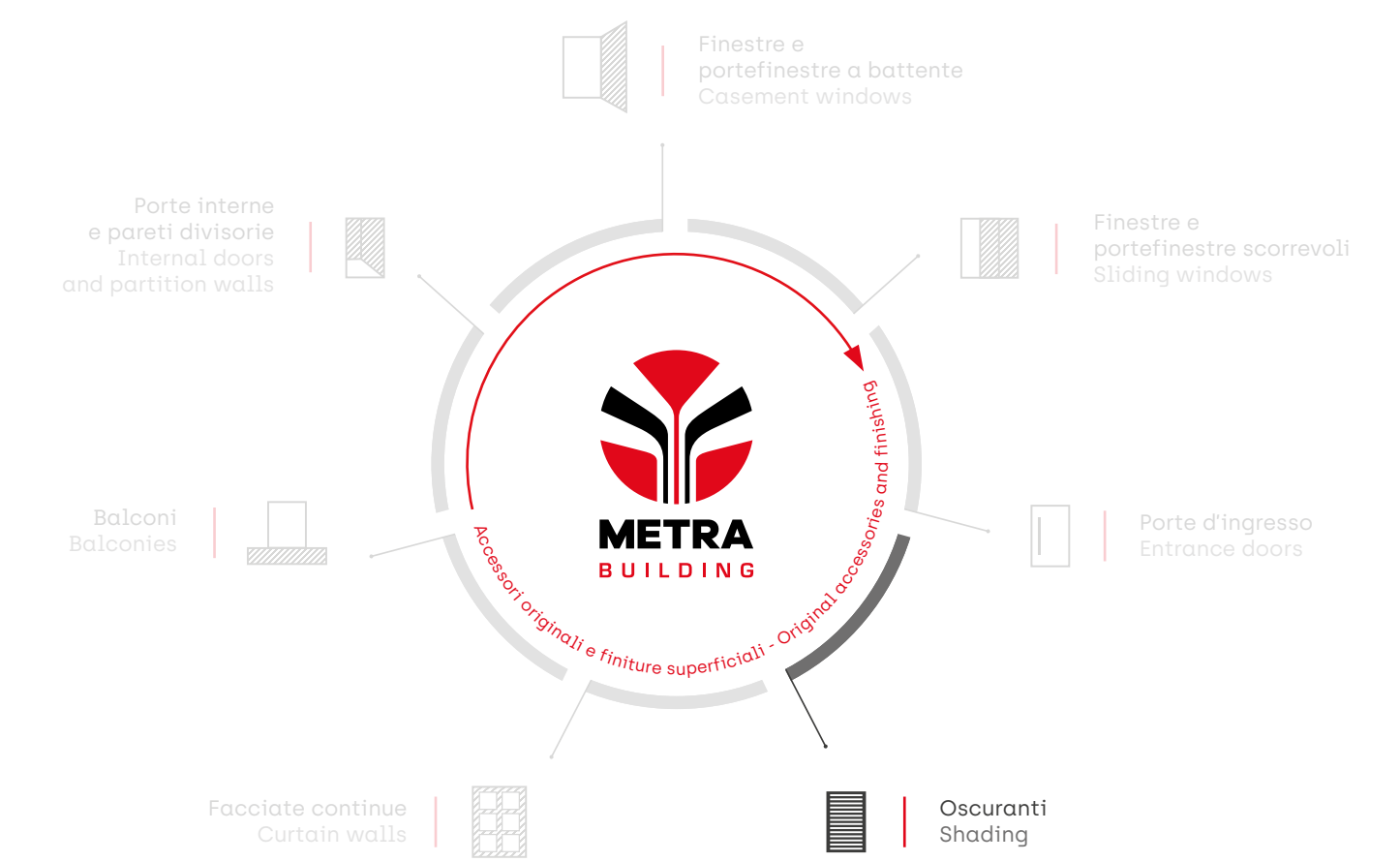

Qualità certificata
Certified quality





Oscuranti in alluminio: perchè METRA Building

Aluminium shutters: why METRA Building

Sistema integrato perfetto

Perfect integrated system

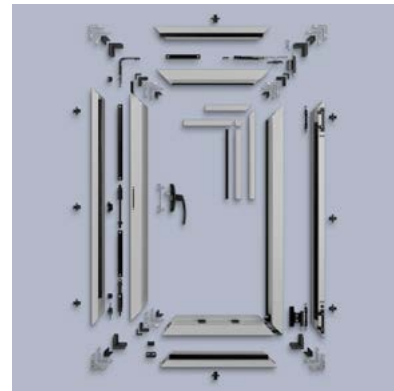

Maniglie, meccanismi di apertura e chiusura, cerniere, guarnizioni e squadrette: tutti gli accessori coordinati, rigorosamente originali METRA Building, si fondono con il serramento per garantire i migliori risultati.

Handles, opening and closing devices, hinges, gaskets and corner cleats: all matching accessories, rigorously METRA Building original, blend with the window or door to guarantee the best results.

Tutti i colori della performance

All colours of performance

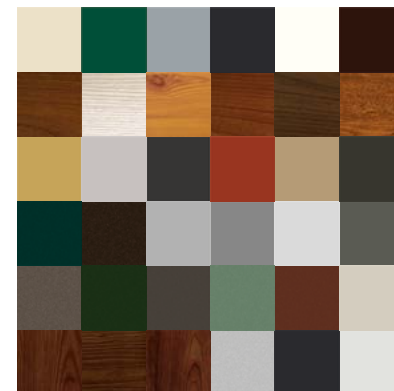

Spazio alla fantasia nella scelta dei colori. Finiture ossidate, verniciature opache, lucide, extralucide e trattamenti effetto legno a marchio Qualanod-Qualicoat-Seaside-Qualideco anche con opzione antibatterica. Durata assicurata fino a 30 anni.

Space for imagination in the choice of colours. Oxidised finishes, matt, gloss, high-gloss and wood-effect treatments under the Qualanod-Qualicoat-Seaside-Qualideco brand also with antibacterial option. Guaranteed durability up to 30 years.

Eccellenza italiana

Italian excellence

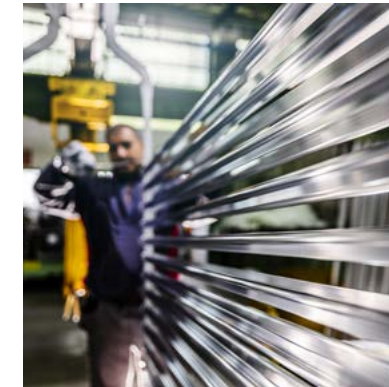

Tutti i serramenti METRA Building sono estrusi in Italia e rispondono alle più selettive certificazioni internazionali. I migliori processi produttivi integrati, uniti a oltre 60 anni di know-how, per creare un prodotto bello, sicuro e dalle prestazioni inimitabili.

All METRA Building windows and doors are extruded in Italy and meet the most selective international certifications. The best integrated production processes, combined with over 60 years of know-how, to create a beautiful and safe product with inimitable performance.

I nostri profili in alluminio sono presenti in alcune delle più prestigiose realizzazioni al mondo: dalla iconica Piramide del Louvre, alle torri di New York fino agli avveniristici grattacieli di Dubai.

Our aluminium profiles are featured in some of the most prestigious projects in the world: from the iconic Louvre Pyramid to the towers of New York and the futuristic skyscrapers of Dubai.

Praticamente eterni

Practically eternal

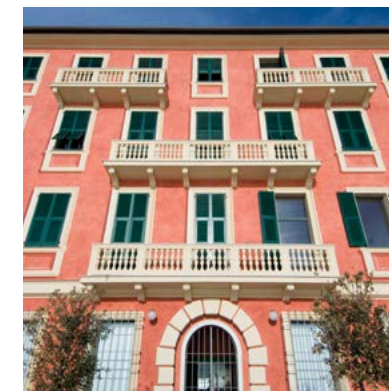

Resistenza meccanica, stabilità, robustezza e manutenzione ridotta ai minimi termini. Numerose qualità e straordinari vantaggi in un unico materiale in grado di durare per sempre.

Mechanical resistance, stability, robustness and maintenance reduced at the minimum. Numerous qualities and extraordinary advantages in a single material able to last forever.



Oscuranti
Shading

Schermatura solare Solar shading



Regolare la quantità di luce e calore per un comfort abitativo e un miglioramento dell'efficienza energetica.

Adjusting the amount of light and heat for living comfort and improved energy efficiency.

Automazione Automation



L'automazione ideale per comfort e praticità senza rinunciare al design. La soluzione automatizzata ultra compatta per persiane scorrevoli Click!Slide permette di chiudere le tue ante premendo un pulsante all'interno dell'abitazione.

The ideal automation for comfort and convenience without sacrificing design. The ultra-compact automated solution for Click!Slide sliding shutters allows you to close your shutters at the push of a button inside your home.





Ecosostenibilità Eco-sustainability

L'alluminio è una scelta sostenibile per gli edifici: ha un'elevata durabilità, ridotta manutenzione e può essere riciclato al 100% e all'infinito, senza perdere le sue proprietà.

L'attenzione per la riduzione dell'impatto ambientale di Metra riguarda tutta la catena del valore dell'alluminio, grazie all'elevato contenuto di materiale riciclato nei profili e l'assenza di VOC, che si concretizza nelle certificazioni ambientali (EPD) ottenute sui prodotti.

Metra Building mette a disposizione un portafoglio di soluzioni per garantire una progettazione sostenibile a basso impatto ambientale, che garantiscono efficienza energetica e favoriscono l'utilizzo della luce naturale, in linea con i requisiti dei protocolli LEED, BREEAM, DGNB e il rispetto dei Criteri Ambientali Minimi.

Aluminium is a sustainable choice for buildings: it has high durability, low maintenance and can be recycled 100% and infinitely without losing its properties.

The attention to reducing Metra's environmental impact concerns the entire aluminium value chain, thanks to the high content of recycled material in the profiles and the absence of VOCs, which is reflected in the environmental certifications (EPD) obtained on the products.

Metra Building offers a portfolio of solutions to guarantee sustainable design with low environmental impact, which guarantee energy efficiency and support the use of natural light, in line with the requirements of LEED, BREEAM, DGNB protocols and compliance with Minimum Environmental Criteria.





Oscuranti Shading

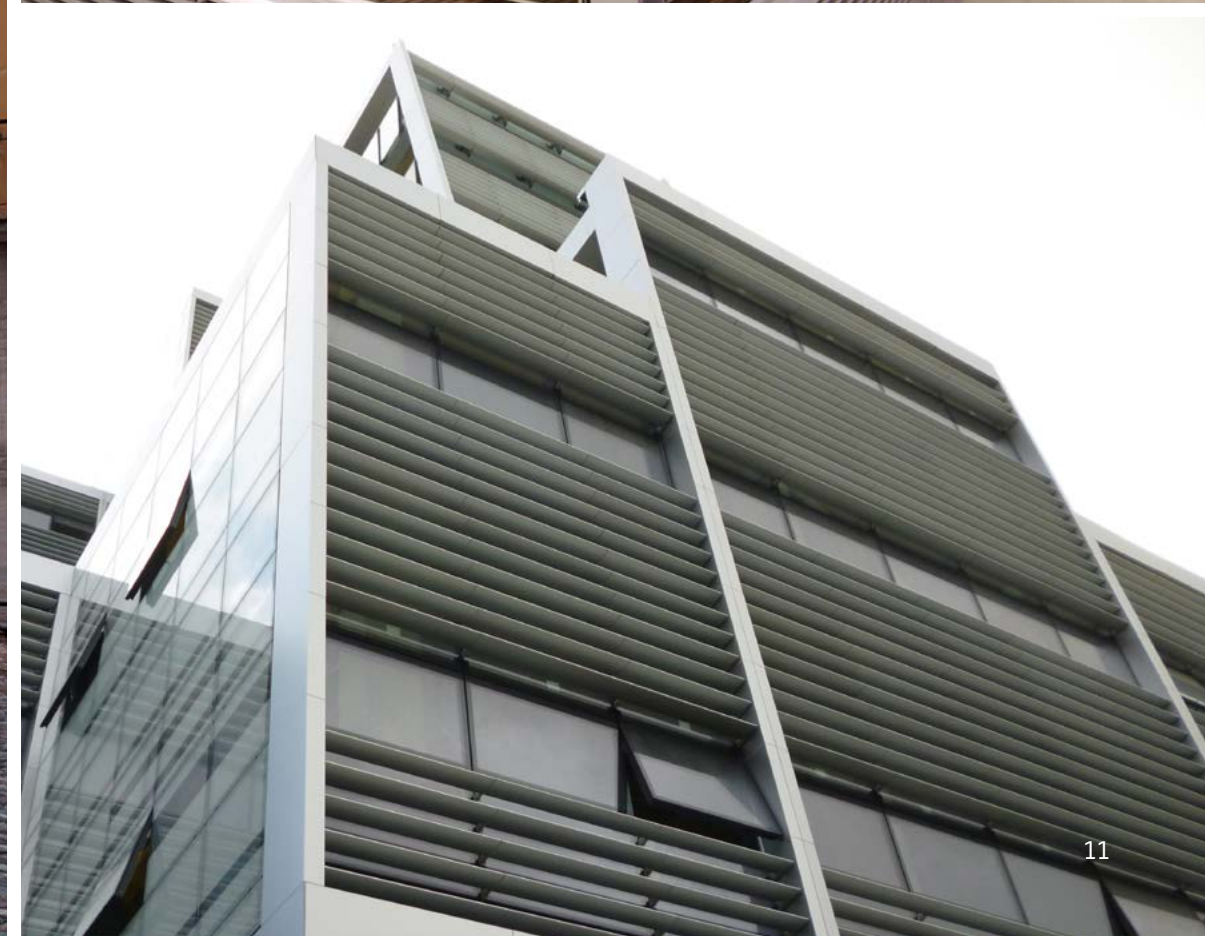



Oscuranti
Shading

Le nostre linee Our product lines

Persiane - Shutters



Linea Origini
Origins line



Linea Scuri
Blinds line



Linea Scorrevoli
Sliding line

Frangisole - Sunblades

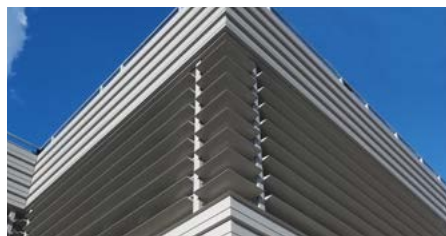

Linea Frangisole
Sunblades line

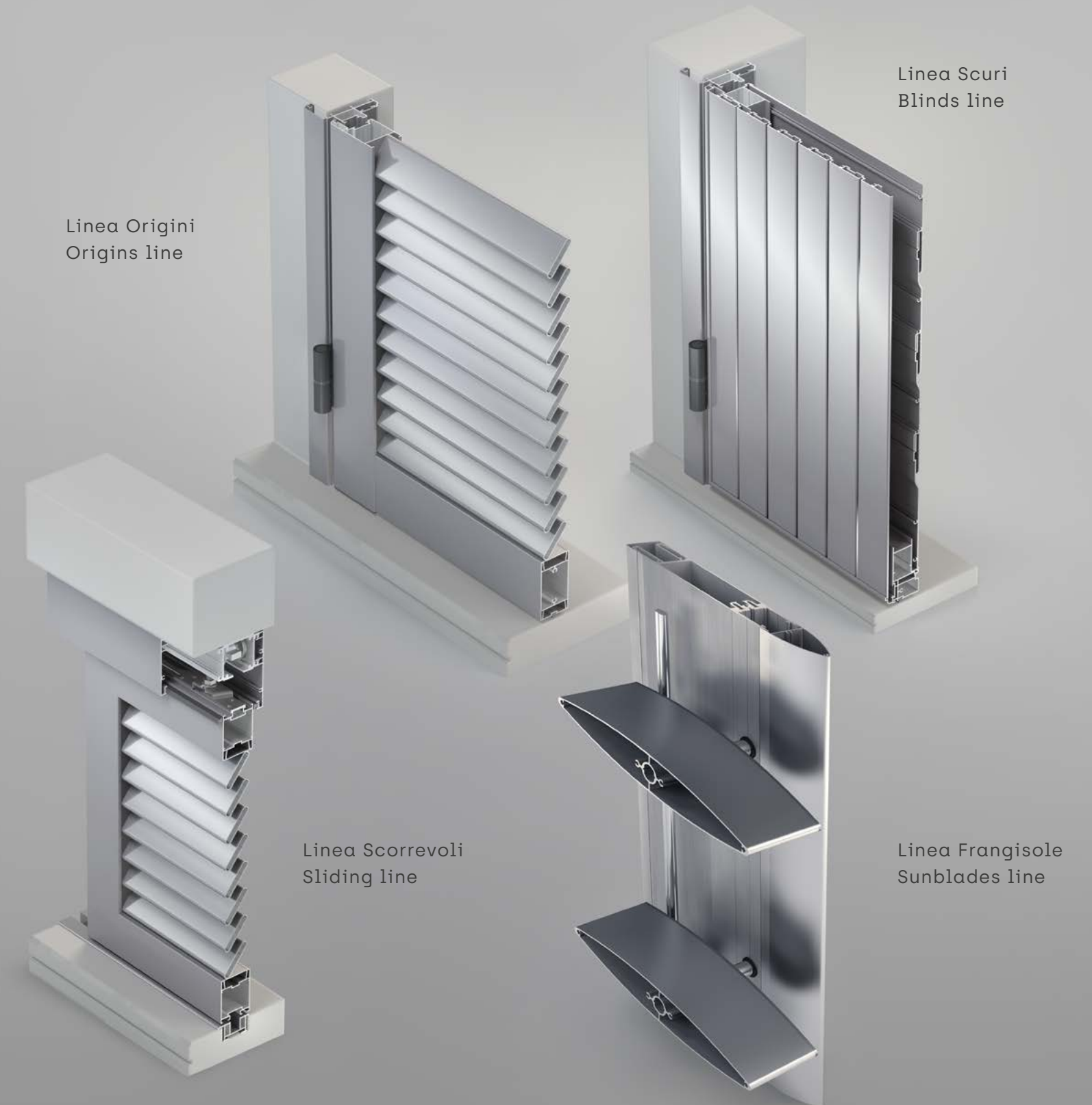



Gli accessori originali METRA Building

The METRA Building original accessories

Persiane - Shutters

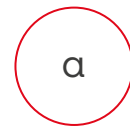

Cerniera Hinge

Robustezza e design in un'unica soluzione. Realizzabile nella stessa finitura, per un'estetica ancora più essenziale.

Stability and design in one solution. Available in the same finish for an even more essential look.

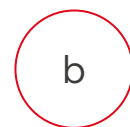

Spagnoletta Espagnolette

L'alternativa di design alla classica chiusura con cremone.

The design alternative to the classic crémone bolt.

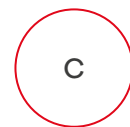

Profilo pretranciato Pre-cut profile

In alluminio, dello stesso colore e nella stessa finitura; perché è il dettaglio che fa la differenza.

In aluminium, in the same colour and finish; because it is the detail that makes the difference.



Giunzione d'angolo Corner joint

Un'ottimale chiusura dell'angolo grazie alla squadretta in alluminio pressofuso posizionata all'interno del profilo.

An optimal corner joint thanks to the die-cast aluminium corner cleat positioned inside the profile.

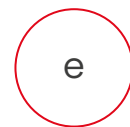

Automazione Automation

Comfort abitativo ai massimi livelli. Semplice, come premere un bottone.

Living comfort at the highest level. As simple as pressing a button.





Gli accessori originali METRA Building

The METRA Building original accessories

Frangisole - Sunblades

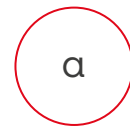

Tappi di finitura Finishing caps

In alluminio, dello stesso colore e nella stessa finitura; perché è il dettaglio che fa la differenza.

Made of aluminium, in the same colour and finish; because it is the detail that makes the difference.

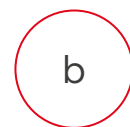

Particolari in acciaio inox Stainless steel details

Resistenti e performanti, per un movimento di rotazione eterno.

Resistant and high-performance, for an eternal rotation movement.

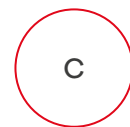

Automazione Automation

Per rendere ancora più veloce e pratico il movimento delle pale.

To make blade movement even faster and more practical.



Hardware di movimentazione Movement hardware

Attuatori, aste e staffe made in METRA Building.

Actuators, rods and brackets made in METRA Building.





Oscuranti
Shading

Persiane
Shutters

Linea Origini
Origins line



CLASSICA

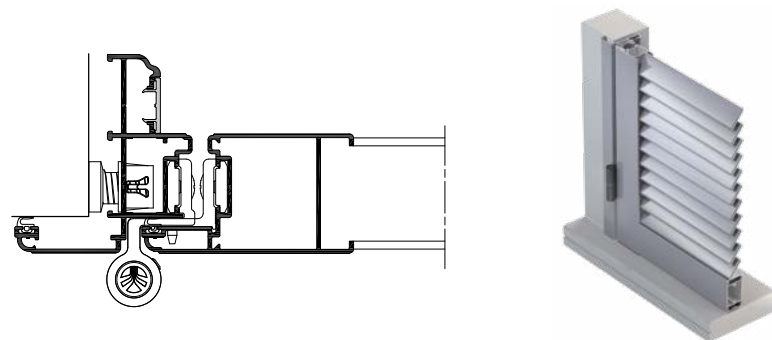

Telaio fisso <i>Frame</i>	Telaio mobile <i>Sash</i>	Scanalatura <i>Groove</i>	Lamelle e ovaline fisse <i>Fixed blades and oval blades</i>
75 mm	45 mm	6 mm	dimensioni e forme variabili <i>dimensions and shapes variable</i>

CENTRO STORICO

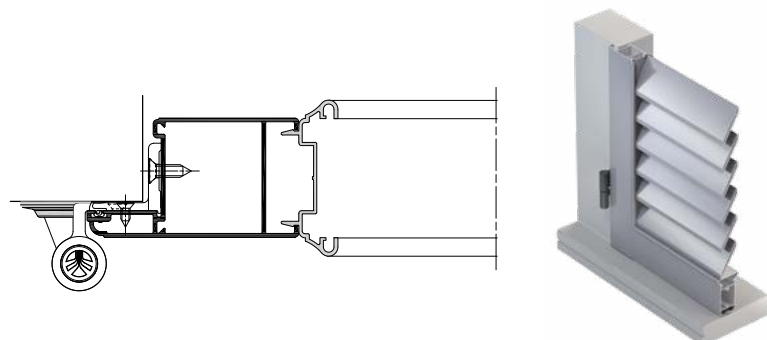

Telaio fisso <i>Frame</i>	Telaio mobile <i>Sash</i>	Profilati di cornice riportata / <i>Inserting frame-profiles</i>	Scanalatura <i>Groove</i>	Lamelle fisse romboidali <i>Fixed rhomboidal blades</i>
75 mm	45 mm	59 mm	6 mm	90 mm

ORIENTABILE

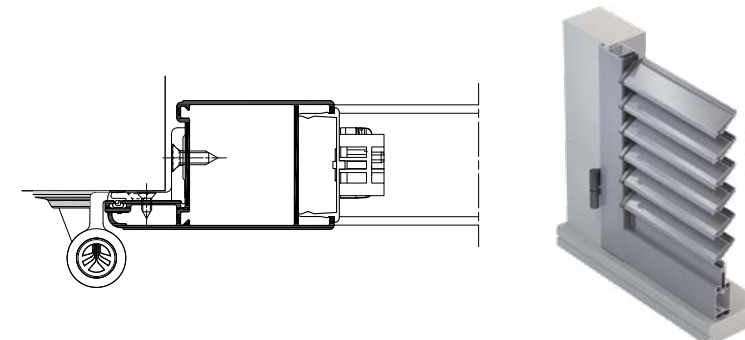

Telaio fisso <i>Frame</i>	Telaio mobile <i>Sash</i>	Scanalatura <i>Groove</i>	Lamelle orientabili <i>Adjustable blades</i>
75 mm	45 mm	6 mm	da 71 mm a goccia <i>from 71 mm drop- shaped</i>

A LIBRO

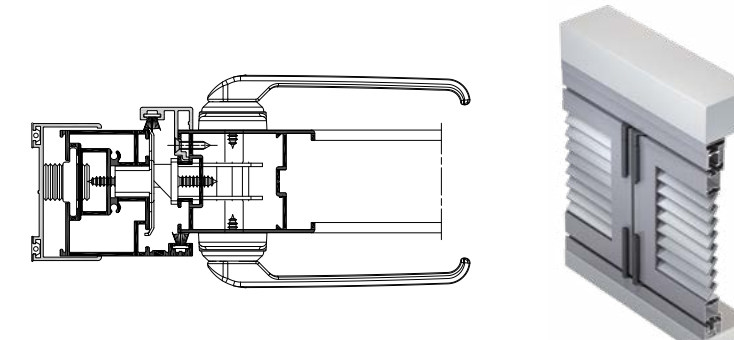

Telaio fisso <i>Frame</i>	Telaio mobile <i>Sash</i>	Scanalatura <i>Groove</i>	Lamelle fisse <i>Fixed blades</i>
55 mm	45 mm	tra telaio fisso laterale ed anta / <i>between frame and sash: 10 mm</i> sul nodo centrale / <i>on the central junction: 10 mm</i> tra un profilato fisso superiore - <i>inferiore ed anta / between upper - lower frame and sash: 12,5 mm</i>	50 - 65 mm

FIRENZE

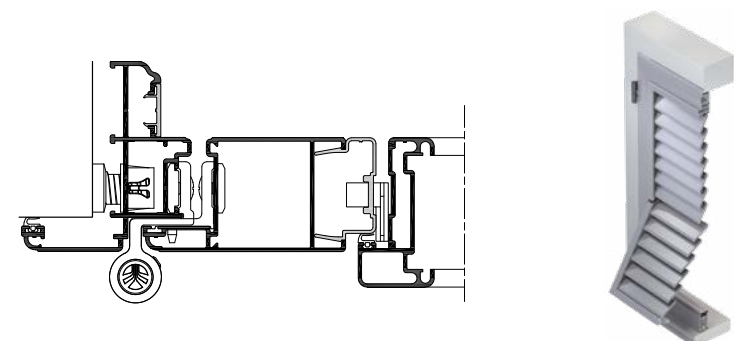

Telaio fisso <i>Frame</i>	Telaio mobile <i>Sash</i>	Scanalatura <i>Groove</i>	Lamelle fisse romboidali <i>Fixed rhomboidal blades</i>
75 mm	45 mm sportello a scomparsa da 59 mm / <i>hidden wicket from 59 mm</i>	5 mm	90 mm

GENOVA

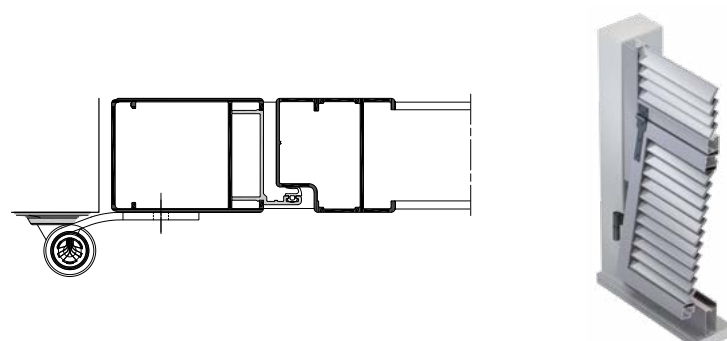

Telaio mobile <i>Sash</i>	Scanalatura <i>Groove</i>	Lamelle fisse <i>Fixed blades</i>
in luce profondità / <i>within the clear span deep: 45 mm</i> sportello profondità / <i>wicket deep: 45 mm</i>	5 mm	50 mm



Oscuranti
Shading

Persiane
Shutters

Linea Scuri Blinds Line



SCURO

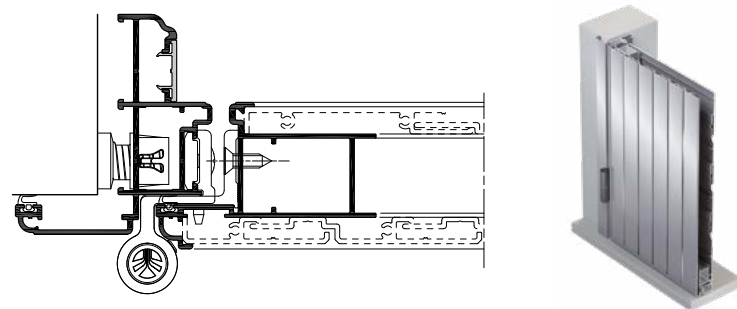

Telaio fisso Frame	Telaio mobile Sash	Scanalatura Groove	Doghe Staves
75 mm	45 mm	6 mm	soluzione verticale / <i>vertical solution:</i> 50 - 60 - 70 mm soluzione orizzontale / <i>horizontal solution:</i> 110 - 180 mm

SCURETTO

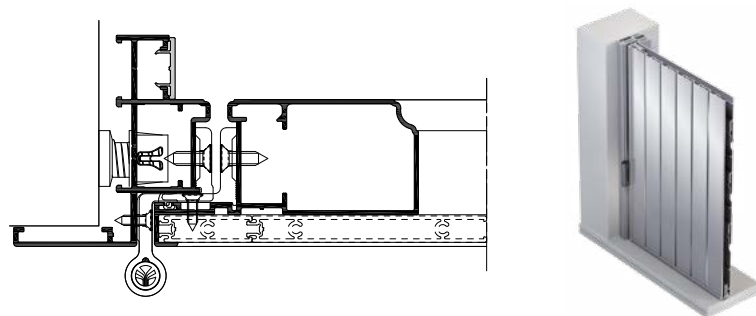

Telaio fisso Frame	Telaio mobile Sash	Scanalatura Groove	Doghe Staves
65 mm	30 mm	6 mm	soluzione verticale / <i>vertical solution:</i> 50 - 60 - 70 mm soluzione orizzontale / <i>horizontal solution:</i> 110 - 180 mm





Oscuranti
Shading

Persiane
Shutters

Linea Scorrevoli Sliding Line



Caratteristiche linea / Line features

AUTOMAZIONE

L'automazione ideale per comfort e praticità senza rinunciare al design. La soluzione automatizzata ultra compatta per persiane scorrevoli Click!Slide permette di chiudere le tue ante premendo un pulsante all'interno dell'abitazione.

AUTOMATION

The ideal automation for comfort and convenience without sacrificing design. The ultra-compact automated solution for Click!Slide sliding shutters allows you to close your shutters at the push of a button inside your home.

SCORREVOLE

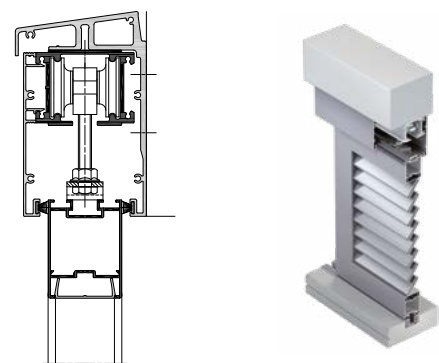

Telaio fisso Frame	Telaio mobile Sash	Scanalatura Groove	Lamelle fisse Fixed blades
scorrevole a libro profondità folding/sliding shutter deep 55 mm	45 mm	10 mm	50 - 65 mm orientabili a goccia da / adjustable drop-shaped: 71 mm

MILANO

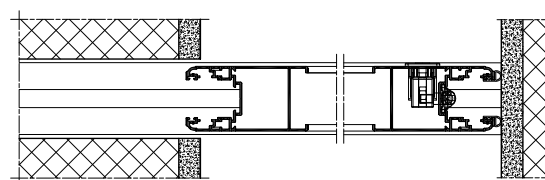

Telaio fisso Frame	Telaio mobile Sash	Lamelle fisse Fixed blades
scorrevole a scomparsa retractable sliding 55 mm	45 mm	50 - 65 mm





Oscuranti
Shading

Frangisole
Sunblades

Linea Frangisole
Sunblades line



Caratteristiche linea / Line features

Straordinario lo stile contemporaneo ed evoluto che il sistema Frangisole METRA Building è in grado di offrire. La nuova serie Frangisole è più di un semplice strumento di protezione solare: la sua applicazione va dal building alla casa privata e valorizza esteticamente qualsiasi forma architettonica. Ogni tipologia di habitat diventa gratificante e maggiormente vivibile nella scelta tra luce, penombra e scuro, a qualsiasi ora della giornata e con grande facilità.

The contemporary and evolved style that the METRA Building Sunblades system is capable of offering is truly extraordinary. The new Sunblades series is more than a simple instrument for sun protection: its application goes from the building to the private house and aesthetically improves almost any architectural form. Any habitat typology becomes rewarding and more liveable given the choice between light, shadow and dark, at any time of the day and with great ease.

FRANGISOLE

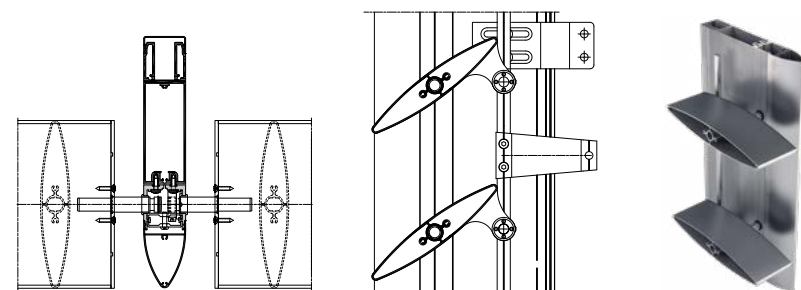

Larghezze lamelle in alluminio estruso di sezione ellittica
Extruded aluminum slat widths of elliptical section

100, 150, 200, 250, 300, 350, 400 e 450 mm

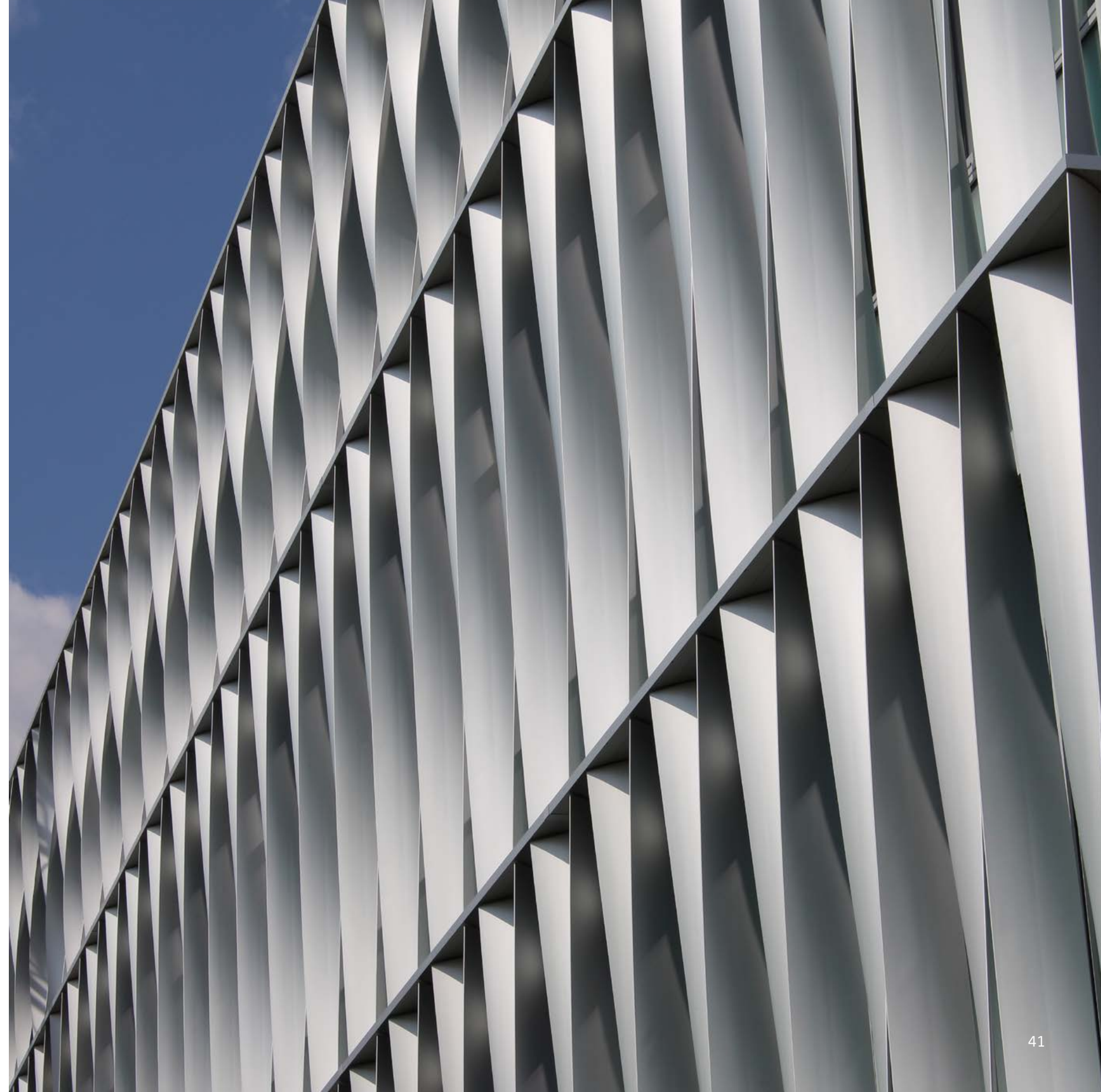



Tipologie di frangisole

Sunblades typologies

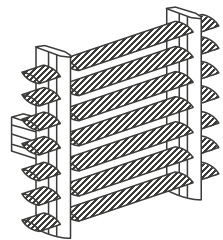

D1 - Frangisole orizzontale.
Angoli prestabiliti e variabili.
Collegabile alle facciate continue METRA Building ed alla muratura.
D1 - Horizontal sunblades. Angles are preset and variable. Can be connected to the METRA Building curtain walls and to the wall.

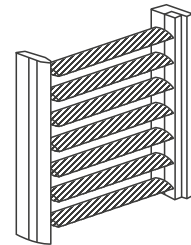

D3 - Frangisole orizzontale.
Angoli prestabiliti e variabili.
Collegabile frontalmente e lateralmente alla muratura ed alle sottostrutture in acciaio.
D3 - Horizontal sunblades. Angles are preset and variable. Can be connected frontally and laterally to the wall and to the steel substructure.

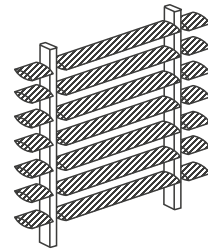

D5 - Frangisole orizzontale.
Angoli prestabiliti e variabili.
Collegabile frontalmente e lateralmente alla muratura ed alle sottostrutture in acciaio.
D5 - Horizontal sunblades. Angles are preset and variable. Can be connected frontally and laterally to the wall and to the steel substructure.

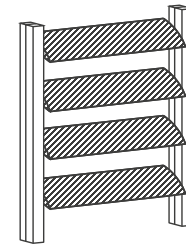

D7 - Frangisole orizzontale.
Angoli prestabiliti.
D7 - Horizontal sunblades. Preset angles.

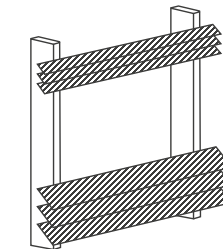

D10 - Frangisole orizzontale fisso per sottostruttura.
D10 - Fixed horizontal sunblades for substructure.

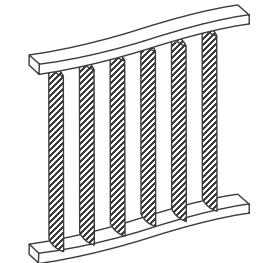

D12 - Frangisole verticale per sottostruttura. Angoli prestabiliti.
D12 - Vertical sunblades for substructure. Preset angles.

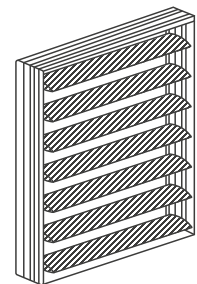

D2 - Frangisole orizzontale a cellule. Angoli prestabiliti e variabili. Collegabile alle facciate continue METRA Building ed alla muratura.
D2 - Horizontal unit sunblades. Angles are present and variable. Can be connected to the METRA Building curtain walls and to the wall.

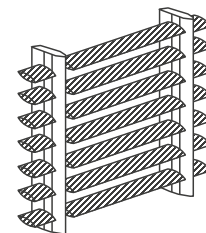

D4 - Frangisole orizzontale per sottostruttura. Angoli prestabiliti e variabili.
D4 - Horizontal sunblades for substructure. Angles are preset and variable.

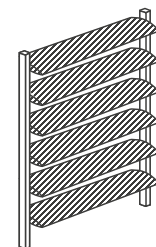

D6 - Frangisole orizzontale per sottostruttura. Angoli prestabiliti e variabili.
D6 - Horizontal sunblades for substructure. Angles are preset and variable.

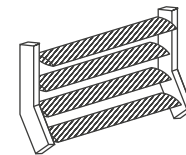

D8 - Frangisole orizzontale per sottostruttura. Angoli prestabiliti.
D8 - Horizontal sunblades for substructure. Preset angles.

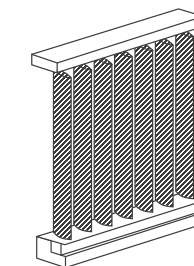

D11 - Frangisole verticale. Angoli prestabiliti e variabili. Collegabile frontalmente e lateralmente allamuratura ed alle sottostrutture in acciaio.
D11 - Vertical sunblades. Preset and variable angles. Can be connection frontally and laterally to the wall and to the steel substructure.

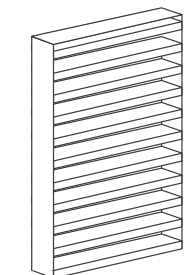

D13 - Frangisole orizzontale scorrevole.
D13 - Horizontal sliding sunblades.

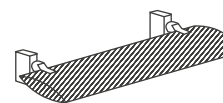

D9 - Frangisole orizzontale per sottostruttura. Angoli prestabiliti.
D9 - Horizontal sunblades for substructure. Preset angles.



Oscuranti
Shading

Frangisole
Sunblades

Linea Frangisole
Sunblades line

Tipologie ovaline

Oval blades typologies

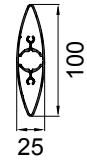

Tipologia 1 / *Typologies 1*

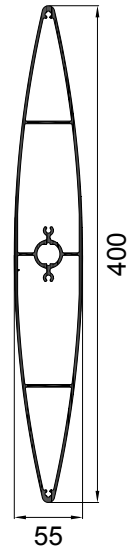

Tipologia 7 / *Typologies 7*

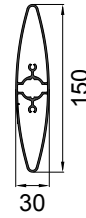

Tipologia 2 / *Typologies 2*

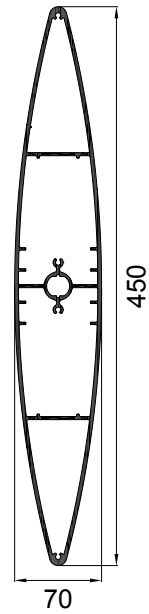

Tipologia 8 / *Typologies 8*

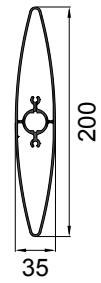

Tipologia 3 / *Typologies 3*

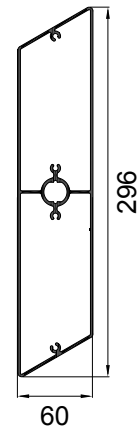

Tipologia 9 / *Typologies 9*

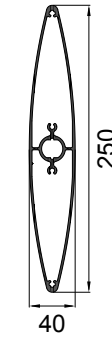

Tipologia 4 / *Typologies 4*

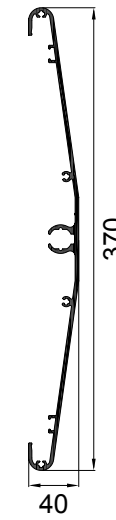

Tipologia 10 / *Typologies 10*

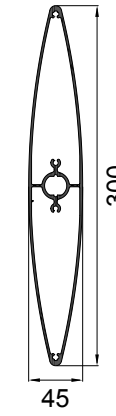

Tipologia 5 / *Typologies 5*

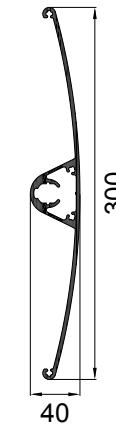

Tipologia 11 / *Typologies 11*

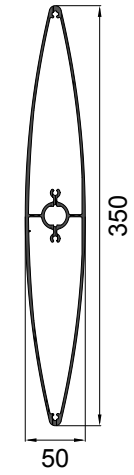

Tipologia 6 / *Typologies 6*

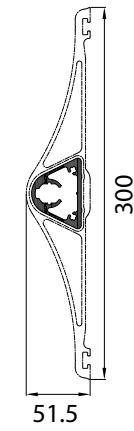

Tipologia 12 / *Typologies 12*



Tecnologia Technology

Persiane - Shutters

- 1 Telaio mobile
- 2 Lamelle od ovaline
- 3 Traverso centrale
- 4 Cerniera per sportello Genova
- 5 Guarnizione di battuta in EPDM
- 6 Cerniera
- 7 Sportello per linea Genova
- 8 Zoccolo

- 1 Sash
- 2 Oval blades
- 3 Transom
- 4 Shutter hinge for wicket Genova
- 5 Rabbit gaskets of EPDM
- 6 Shutter hinge
- 7 Wicket for type Genova
- 8 Base transom

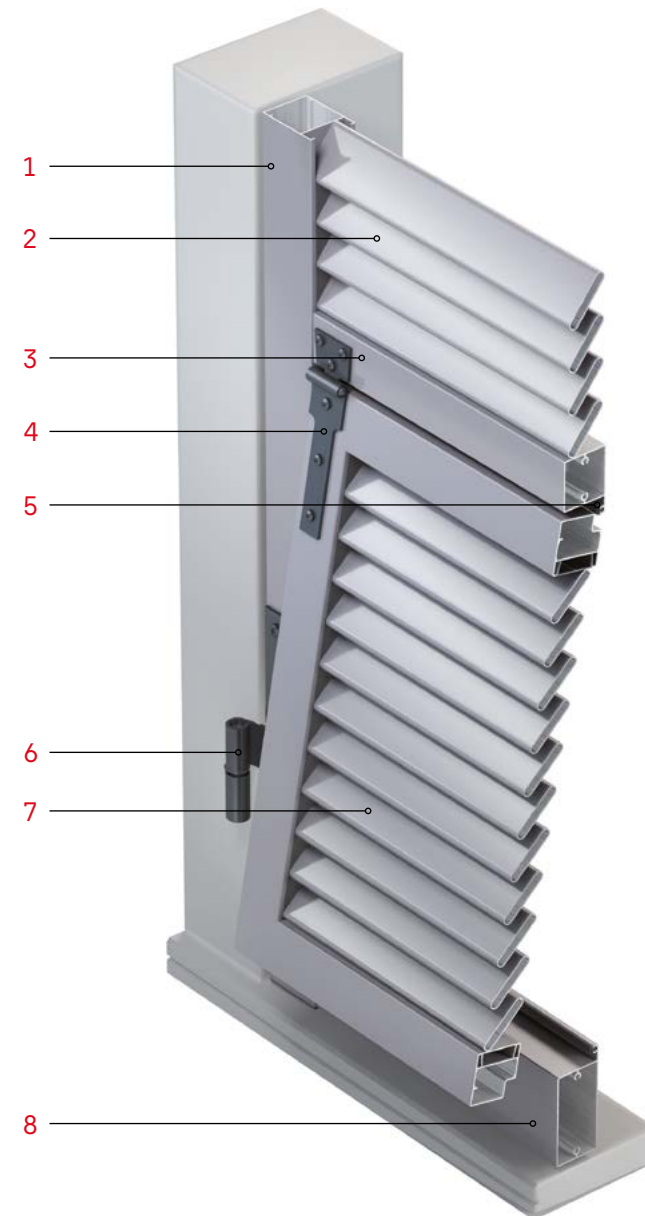

Tecnologia Technology

Frangisole - Sunblades

- 1 Profilato di copertura interno montante
- 2 Montante
- 3 Profilato di copertura esterno montante
- 4 Asse di rotazione
- 5 Lamella ellittica
- 6 Asta di collegamento per movimentazione lamelle

- 1 Internal cover profile of the mullion
- 2 Mullion
- 3 External cover profile of the mullion
- 4 Rotation axis
- 5 Elliptical blade
- 6 Transmission rod for blades control

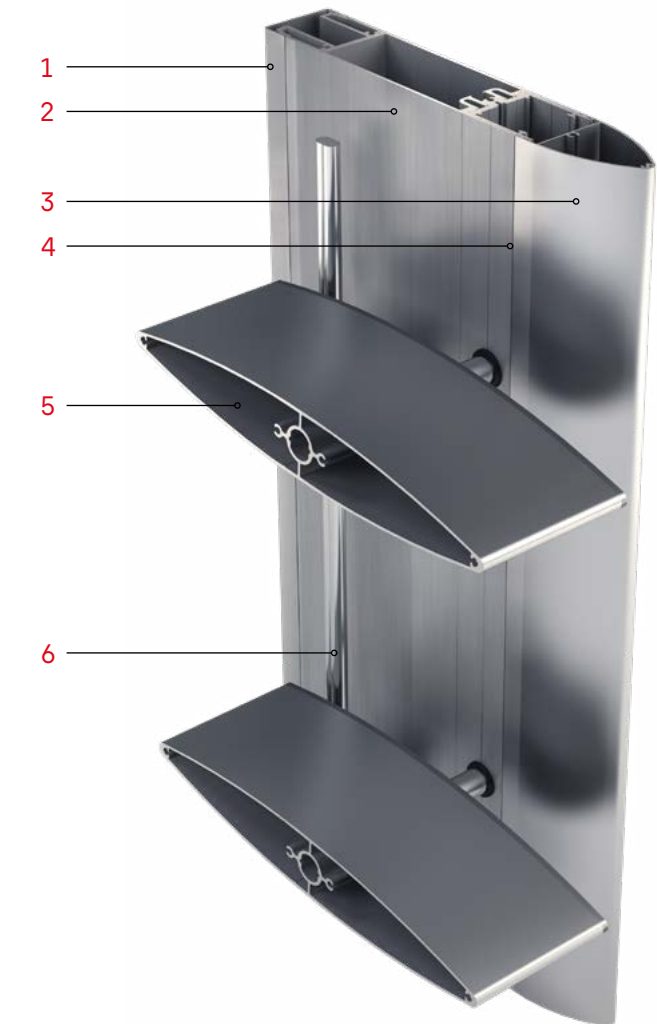





METRA S.p.A

Via Stacca 1,
25050 - Rodengo Saiano
Brescia - Italy
T +39 030 68191
F +39 030 6819990

info@metrabuilding.com

METRA RAGUSA S.p.A.

Zona industriale,
97100 - Ragusa
Italy
T +39 0932 660911
F +39 0932 667224

info.ragusa@metrabuilding.com

METRA ALUMINIUM INC.

2000, boul. Fortin
Laval, QC H7S 1P3
Canada
T (450) 629-4260
F (450) 629-4227

info.canada@metrabuilding.com

METRA USA

Waterford Business Park
5201 Blue Lagoon Drive, Unit #984
Miami, FL 33126
USA
T +1 305-915-0999

info.usa@metrabuilding.com



www.metrabuilding.com